



CenterPoint

SELF-CHECKING SHEAR BEAM STANDS

- Tanks
- Bins
- Hoppers

*Cardinal model
CLDBR10K-3
shown here*

***Light to Heavy Capacity
Mounting Assemblies***

- Stainless Steel Load Cells • Self-Checking, Low-Profile Stands
- Center Load Design • Environmentally-Sealed • Bolts Directly to Floor and Tank

Cardinal's CenterPoint Tank/Hopper Scales utilize double-ended shear beam stainless steel load cells with center load design. The bolt-in-place mounting assembly with articulating top plate makes them ideal for indoor or outdoor weighing applications. Available in three or four legged mounting assemblies with mild or stainless steel stands and self-checking sliding pin design, the CenterPoint load cell kits are perfect for mixing, blending, batching, inventory control, and general weighing. Combine them with one of Cardinal's state-of-the-art 200 series weight indicators for a complete digital weighing system.

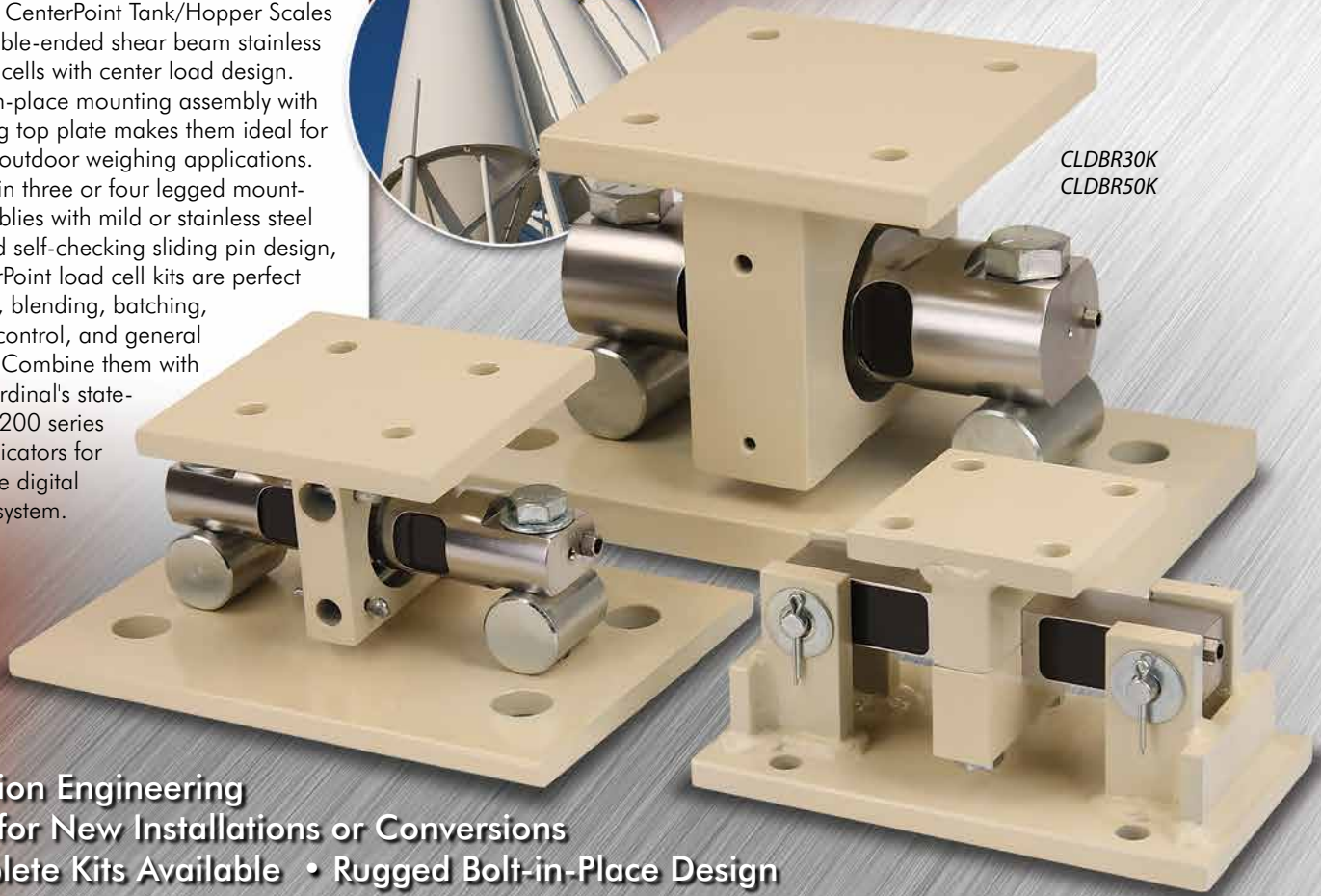

CLDBR30K
CLDBR50K

CLDBR5K
CLDBR10K
CLDBR20K

- Precision Engineering
- Ideal for New Installations or Conversions
- Complete Kits Available • Rugged Bolt-in-Place Design

CLDB2.5K
CLDB5K

Stainless Steel CenterPoint Load Cells



CLDBR30K /
CLDBR50K



CLDBR5K /
CLDBR10K / CLDBR20K



CLDB2.5K / CLDB5K

CLDB LOAD CELLS | Center-Load Double-Ended Shear Beam

MODEL	SHAPE	CONSTRUCTION	CAPACITY	SHIPPING WEIGHT
CLDB2.5K	Square	Stainless Steel	2,500 lb / 1,135 kg	3.5 lb / 1.5 kg
CLDB5K	Square	Stainless Steel	5,000 lb / 2,270 kg	3.5 lb / 1.5 kg
CLDBR5K	Rounded	Stainless Steel	5,000 lb / 2,270 kg	5.5 lb / 2.5 kg
CLDBR10K	Rounded	Stainless Steel	10,000 lb / 4,535 kg	5.5 lb / 2.5 kg
CLDBR20K	Rounded	Stainless Steel	20,000 lb / 9,070 kg	5.5 lb / 2.5 kg
CLDBR30K	Rounded	Stainless Steel	30,000 lb / 13,605 kg	20.5 lb / 9 kg
CLDBR50K	Rounded	Stainless Steel	50,000 lb / 22,700 kg	20.5 lb / 9 kg



Weighing capacities available ranging from 2,500 to 50,000 lb / 1,135 to 22,700 kg.

Rated Output:	3mV/V
Combined Error:	0.03% of rated output
Protection Class:	IP68
Cable Length:	30 feet / 9 meter
Construction:	Stainless Steel



CenterPoint

SELF-CHECKING SHEAR BEAM STANDS

CenterPoint load cell kits contain either 3 or 4 stand assemblies, corresponding number of stainless steel load cells with 30 ft / 9 m of load cell cable, and 1 stainless steel junction box.

3 LOAD CELL SYSTEMS | Mild Steel Stands

MODEL	CELL SHAPE	CELL CONSTRUCTION	CELL CAPACITY	SYSTEM CAPACITY	SHIPPING WEIGHT
CLDB2.5K-3	Square	Stainless Steel	2,500 lb / 1,135 kg	7,500 lb / 3,405 kg	67 lb / 30 kg
CLDB5K-3	Square	Stainless Steel	5,000 lb / 2,270 kg	15,000 lb / 6,810 kg	67 lb / 30 kg
CLDBR5K-3	Rounded	Stainless Steel	5,000 lb / 2,270 kg	15,000 lb / 6,810 kg	94 lb / 43 kg
CLDBR10K-3	Rounded	Stainless Steel	10,000 lb / 4,535 kg	30,000 lb / 13,605 kg	94 lb / 43 kg
CLDBR20K-3	Rounded	Stainless Steel	20,000 lb / 9,070 kg	60,000 lb / 27,210 kg	94 lb / 43 kg
CLDBR30K-3	Rounded	Stainless Steel	30,000 lb / 13,605 kg	90,000 lb / 40,824 kg	343 lb / 156 kg
CLDBR50K-3	Rounded	Stainless Steel	50,000 lb / 22,700 kg	150,000 lb / 68,040 kg	343 lb / 156 kg

3 LOAD CELL SYSTEMS | Stainless Steel Stands

MODEL	CELL SHAPE	CELL CONSTRUCTION	CELL CAPACITY	SYSTEM CAPACITY	SHIPPING WEIGHT
CLDBS2.5K-3	Square	Stainless Steel	2,500 lb / 1,135 kg	7,500 lb / 3,405 kg	67 lb / 30 kg
CLDBS5K-3	Square	Stainless Steel	5,000 lb / 2,270 kg	15,000 lb / 6,810 kg	67 lb / 30 kg
CLDBRS5K-3	Rounded	Stainless Steel	5,000 lb / 2,270 kg	15,000 lb / 6,810 kg	94 lb / 43 kg
CLDBRS10K-3	Rounded	Stainless Steel	10,000 lb / 4,535 kg	30,000 lb / 13,605 kg	94 lb / 43 kg
CLDBRS20K-3	Rounded	Stainless Steel	20,000 lb / 9,070 kg	60,000 lb / 27,210 kg	94 lb / 43 kg
CLDBRS30K-3	Rounded	Stainless Steel	30,000 lb / 13,605 kg	90,000 lb / 40,824 kg	343 lb / 156 kg
CLDBRS50K-3	Rounded	Stainless Steel	50,000 lb / 22,700 kg	150,000 lb / 68,040 kg	343 lb / 156 kg

4 LOAD CELL SYSTEMS | Mild Steel Stands

MODEL	CELL SHAPE	CELL CONSTRUCTION	CELL CAPACITY	SYSTEM CAPACITY	SHIPPING WEIGHT
CLDB2.5K-4	Square	Stainless Steel	2,500 lb / 1,135 kg	10,000 lb / 4,540 kg	87 lb / 39 kg
CLDB5K-4	Square	Stainless Steel	5,000 lb / 2,270 kg	20,000 lb / 9,080 kg	87 lb / 39 kg
CLDBR5K-4	Rounded	Stainless Steel	5,000 lb / 2,270 kg	20,000 lb / 9,080 kg	124 lb / 56 kg
CLDBR10K-4	Rounded	Stainless Steel	10,000 lb / 4,535 kg	40,000 lb / 18,140 kg	124 lb / 56 kg
CLDBR20K-4	Rounded	Stainless Steel	20,000 lb / 9,070 kg	80,000 lb / 36,280 kg	124 lb / 56 kg
CLDBR30K-4	Rounded	Stainless Steel	30,000 lb / 13,605 kg	120,000 lb / 54,420 kg	456 lb / 207 kg
CLDBR50K-4	Rounded	Stainless Steel	50,000 lb / 22,700 kg	200,000 lb / 90,800 kg	456 lb / 207 kg

4 LOAD CELL SYSTEMS | Stainless Steel Stands

MODEL	CELL SHAPE	CELL CONSTRUCTION	CELL CAPACITY	SYSTEM CAPACITY	SHIPPING WEIGHT
CLDBS2.5K-4	Square	Stainless Steel	2,500 lb / 1,135 kg	10,000 lb / 4,540 kg	87 lb / 39 kg
CLDBS5K-4	Square	Stainless Steel	5,000 lb / 2,270 kg	20,000 lb / 9,080 kg	87 lb / 39 kg
CLDBRS5K-4	Rounded	Stainless Steel	5,000 lb / 2,270 kg	20,000 lb / 9,080 kg	124 lb / 56 kg
CLDBRS10K-4	Rounded	Stainless Steel	10,000 lb / 4,535 kg	40,000 lb / 18,140 kg	124 lb / 56 kg
CLDBRS20K-4	Rounded	Stainless Steel	20,000 lb / 9,070 kg	80,000 lb / 36,280 kg	124 lb / 56 kg
CLDBRS30K-4	Rounded	Stainless Steel	30,000 lb / 13,605 kg	120,000 lb / 54,420 kg	456 lb / 207 kg
CLDBRS50K-4	Rounded	Stainless Steel	50,000 lb / 22,700 kg	200,000 lb / 90,800 kg	456 lb / 207 kg

CENTERPOINT STAND DIMENSIONS

CLDB 2.5K / 5K

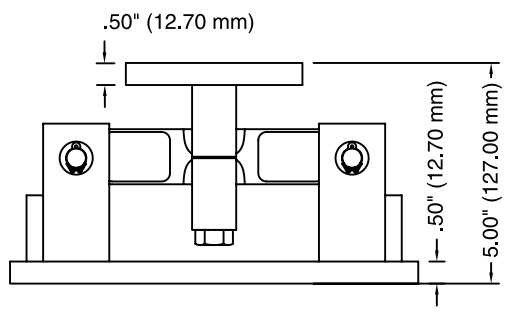
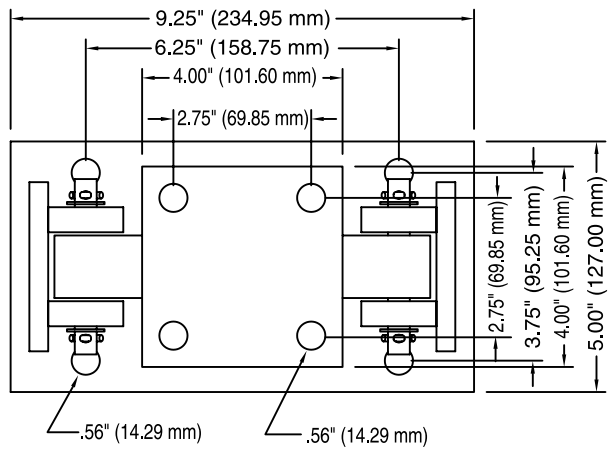

CLDBR 5K / 10K / 20K

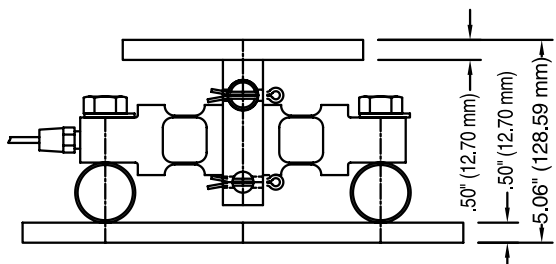
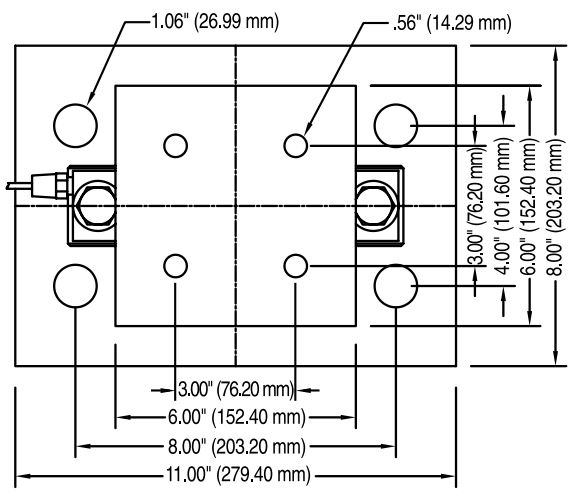

CLDBR 30K / 50K

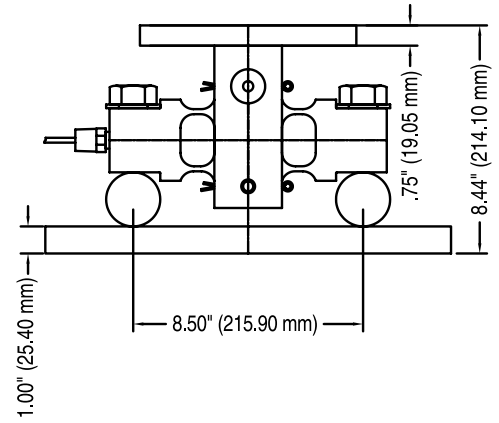
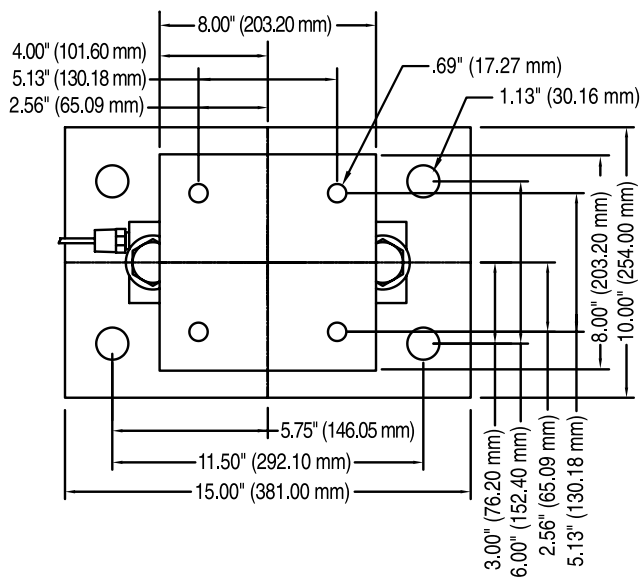

Cardinal Scale reserves the right to improve, enhance or modify features and specifications without prior notice. All registered trademarks are the property of their respective owners.

Cardinal
 Cardinal Scale Manufacturing Co.
 102 E. Daugherty, Webb City, MO 64870 USA
 Pb: 417-673-4631 or 800-441-4237 • Fax: 417-673-2153
www.CardinalScale.com

SOLD BY:

