

C3 Series



rinstrum

SMART WEIGHING SOLUTIONS



C350/C357

C350/ C357 Full Housing indicators

- 2in (50.8mm) LCD display with backlight
- RGB backlight to make check weighing easy
- 9 segment display for improved readability
- Wide DC operation (5-24V) ideal for onboard vehicle and industrial applications



Flush polyester overlay with mechanical keys

- No membrane keys to wear out
- Easy to keep clean
- Fully sealed: C350 is IP65 (NEMA 4) & C357 is IP66 (NEMA 4X).
- Durable chemical resistance
- High UV Resistance

Dual serial outputs

Serial outputs are fully customizable to allow the C3 to emulate the output as well as respond to the serial commands for most common indicator brands. This means that in most cases it is possible to use the C3 as a direct drop-in replacement in legacy systems.

Firmware applications

- Custom printing
- Accumulation
- Counting
- Checkweighing
- Manual hold, peak hold, medical and livestock filtering
- Mimic/ remote display
- Advanced setpointing including latching outputs

RGB LCD Display
(Selectable up to 9 colors)

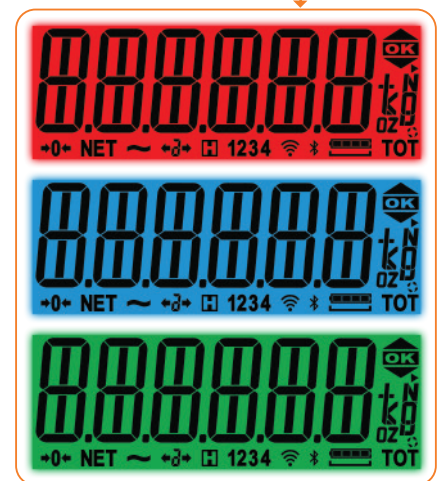

viewC3 for fast, simple indicator setup via a PC

viewC3 is PC software that displays the complete menu structure of the indicator with convenient drop down menus for setting selection. Use viewC3 to:

- Enter custom print strings using the PC.
- Setup the indicator and save the configuration and calibration for maintenance purposes or load the RIS file onto multiple indicators.
- Create a real time graph from the log that is ideal for diagnostics.

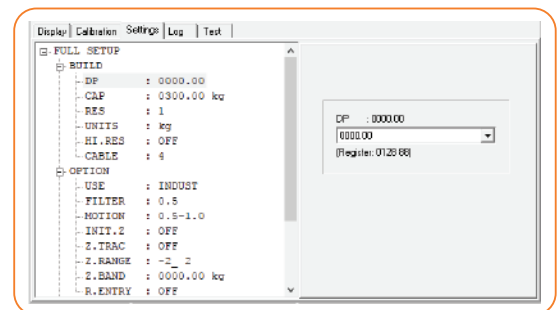

rinLINK for establishing a temporary connection to a PC

The rinLINK provides an isolated optical serial connection directly on the front of the indicator. It is magnetically coupled for easy access in situ for updates/ setup of the indicator, saving the installer time and effort.

The rinLINK can be used to download new firmware or provide the connection to the PC running Viewer for indicator configuration.



C350 / C357 rear

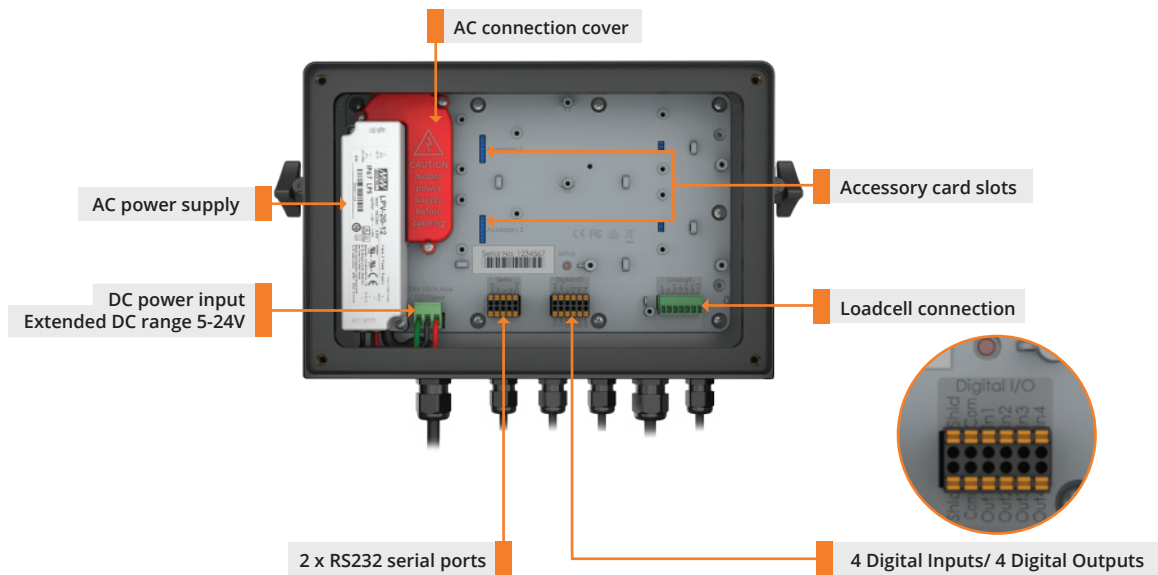

Built-in features (enabled according to firmware)

- Two RS232 bidirectional serial ports independently configurable for network, printing or remote display functions
- Four digital inputs and four high-side digital outputs that are electrically isolated. Outputs are capable of driving low voltage DC actuators directly
- Non-volatile memory storage for all operator parameters (eg: zero, tare, pieceweight etc.)
- Realtime clock calendar
- Integrated alibi memory (DSD)
- RGB backlight for setpoint and checkweigh applications
- Two accessory card slots for increased functionality

Accessory cards

Communications cards

In addition to the two built in RS232 ports, a third serial port can be added to extend the connectivity. This serial port can be 20mA current loop, RS232, or RS485.

Expansion cards

Expansion cards can be used instead of communication cards to extend the capability of the C3. Options include:

- Analog output 4-20mA, 0-10V, isolated 16 bit output
- Ethernet IP, Profinet, Modbus TCP, EtherCat
- Wifi/ Bluetooth

rinPRINT - Rinstrum's custom print wizard

With rinPRINT you set the print width, then drag and drop the print tokens into the editor pane to create a custom print configuration. Add your own text descriptions and format the layout and spacing by moving the field around in the editor pane. The data displayed is the live data from the indicator. rinPRINT makes creating custom print dockets easy.

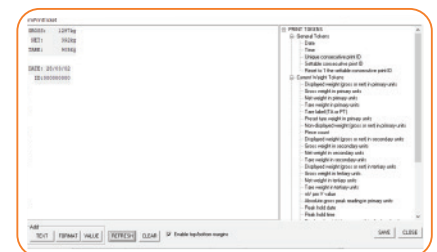

Advanced setpoints

The C3 instruments support up to 8 setpoints with setpoints 1 and 2 linked to the onboard digital outputs. Setpoint status can be used to drive the onboard outputs directly, sound the buzzer, change display backlight color, or can be transferred to external control systems using Modbus RTU or through field bus expansion. Setpoint functions include:

- OVER/ UNDER target
- CHECKWEIGH: OVER, UNDER, PASS
- Status (motion, zero, net)

Setpoint outputs can be latched and reset from remote inputs or external control.

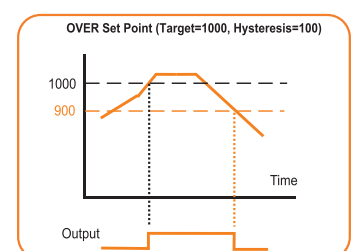

C350 Resin Alloy Full Housing

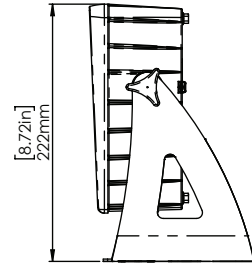
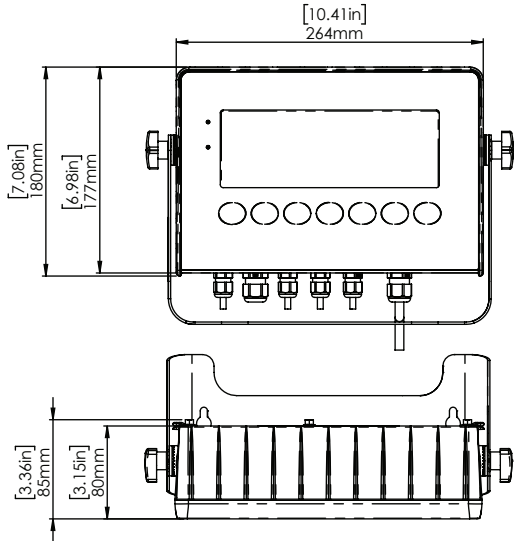

C357 Stainless Steel Housing

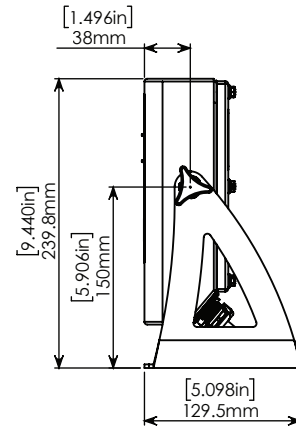
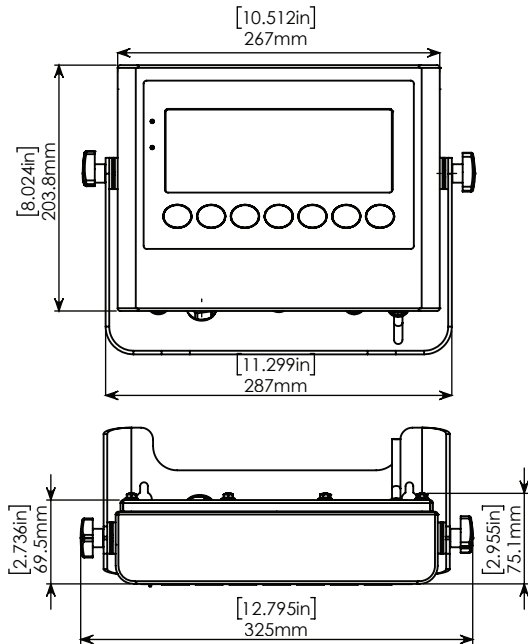

Local Dealer



Contact Us