

R423

R427



rinstrum

SMART WEIGHING SOLUTIONS

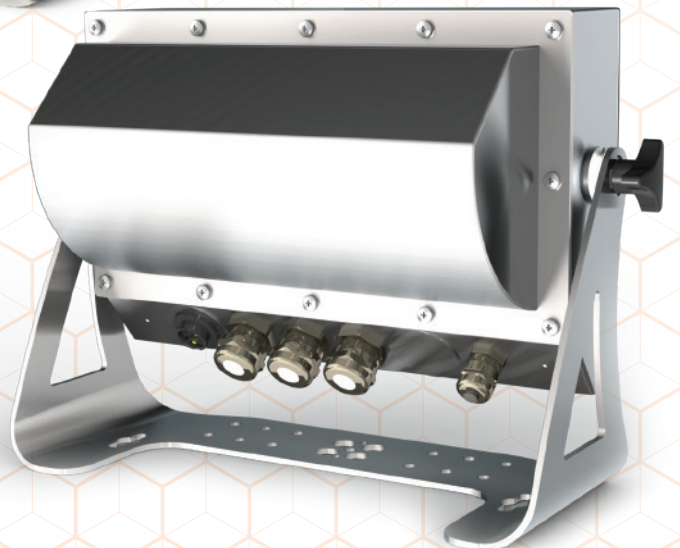

Rinstrum R423/R427 Stainless Steel Indicators

The R400 series of indicators is designed with both the installer and operator in mind and covers a wide range of applications. The indicators are engineered and built to last with reliability being foremost. The modular design allows for the installation to be commissioned with only the components required, saving time and money. R423 is a Panel Mount indicator and R427 is a Full Housing indicator.

Features

- AC and DC options
- LCD with 4 alpha-numeric displays and LED backlighting
- OIML, NMI and NTEP trade approved
- Built-in RS232/RS485
- IP66-rated Stainless Steel housing
- Ethernet support
- Robust precise analogue output module
- Versatile application software

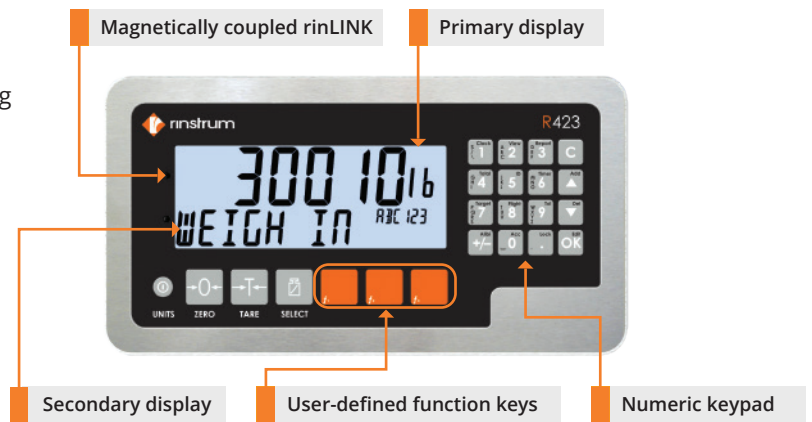

Superior diagnostics and support

- Range of diagnostic tools and features
- Hardware configuration report: summarizes how the indicator hardware is set up, providing a record for maintenance purposes or fault finding
- Force Output and Test Input functions: allow the installer to specifically test I/O to assist in site setup
- Ability to swap modules in and out without recalibration of the indicator

View400 Fast Efficient Indicator setup via a PC

View400 displays the complete menu structure of the indicator on the PC with convenient drop-down menus for setting selection.

- Enter custom print strings using the PC
- Set up the indicator and save the configuration and calibration for maintenance purposes or load the RIS file onto multiple indicators
- Create a real-time graph from the log that is ideal for diagnostics

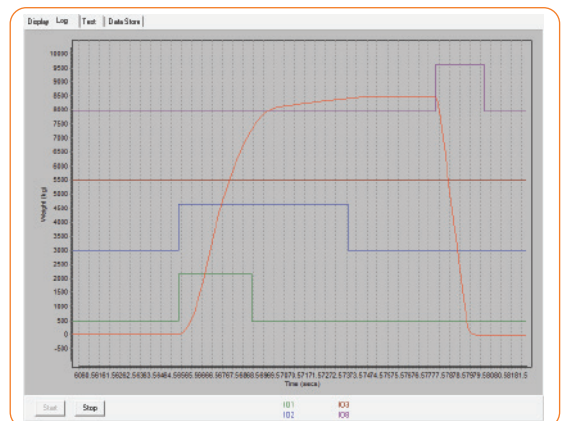
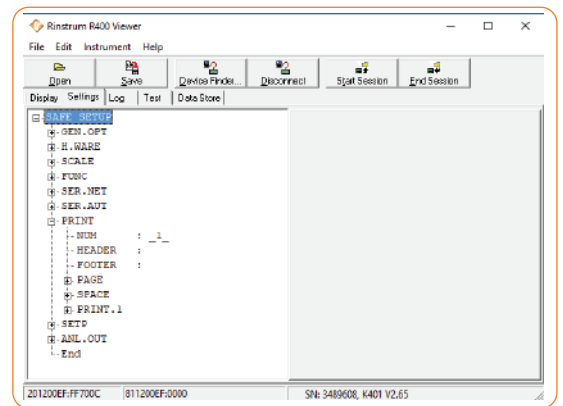

Save400 - Reading and writing Indicator setup

Save400 is a software tool that reads and writes R400 indicator setup and configuration. It allows for a setup to be exported for update and then be reimported.

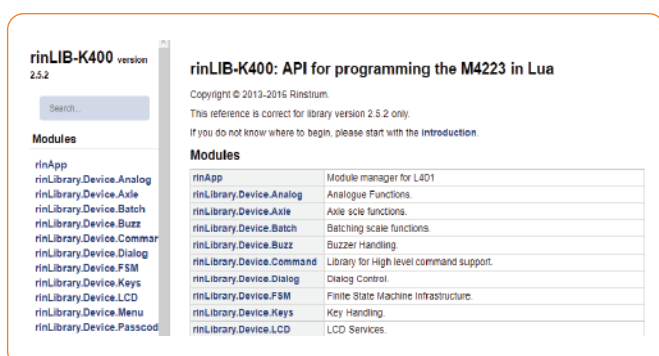

Lua Programmability



- Embedded Lua scripting with accessory module
- Enhance functionality by installing a range of application packages
- Open-source library and comprehensive API enable you to write your own applications or engage Rinstrum to write them for you through our Lua MAX programme
- Use the embeded web server to create browser-based user interfaces

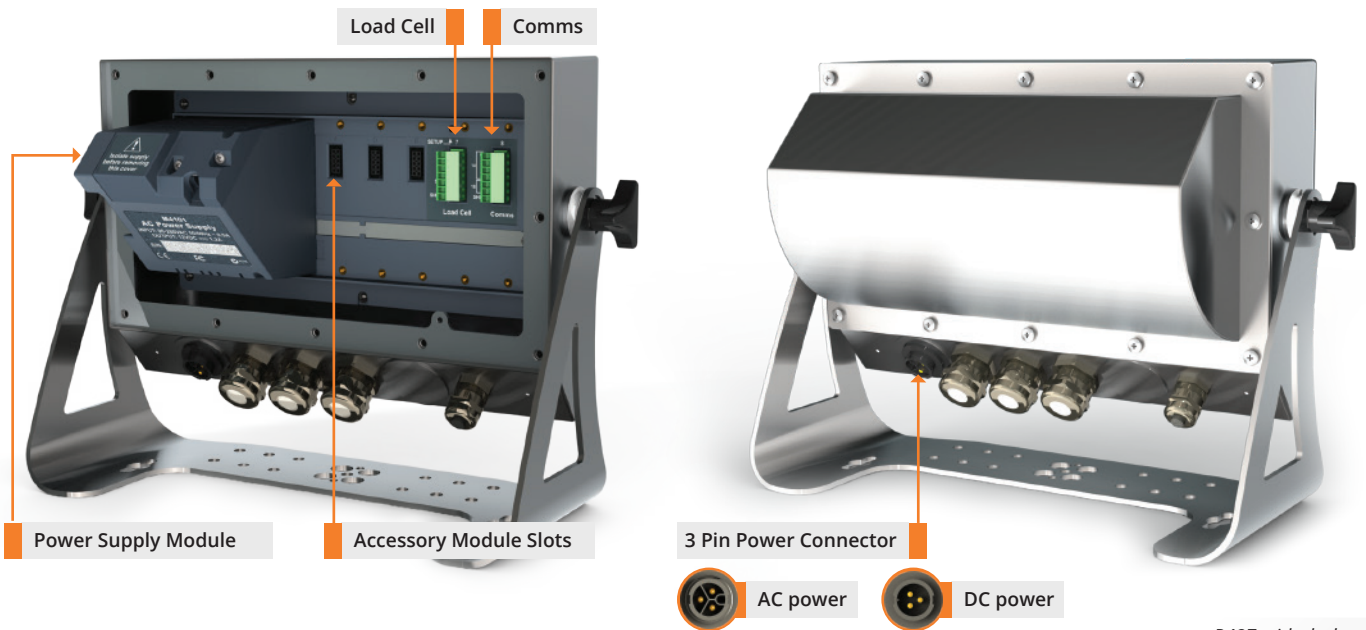

R427 with desk stand

Rugged Load Cell Input

Designed to take 16x350 ohm load cells @0.25uV/D; providing flexibility and reducing the need for summing hardware, simplifying the installation and saving money. The load cell input is protected with onboard transorbs to limit damage from external voltage surges.

rinLINK for establishing a temporary connection to a PC

The rinLINK provides an isolated optical serial connection directly on the front of the indicator. It is magnetically coupled for easy access in situ for updates/setup of the indicator, saving the installer time and effort.

The rinLINK can be used to download new firmware or to provide the connection to the PC running Viewer for indicator configuration.



RS232/ RS232 Module	RS232/RS485 Module	RS485/RS485 Module	AC Module	Lua Module	I/O Module	Button Module	Analogue Output	Data Storage Device Module
<ul style="list-style-type: none"> Electrically isolated RS232 serial communication Status LEDs 	<ul style="list-style-type: none"> Electrically isolated serial communication Status LEDs 	<ul style="list-style-type: none"> Electrically isolated RS485 networking Status LEDs 	<ul style="list-style-type: none"> 110-240 VAC in 12 VDC out 	<ul style="list-style-type: none"> Lua programmability Ethernet Port USB Host Port Telnet/SSH remote access 	<ul style="list-style-type: none"> 8 I/O Configure as input or output Electrically isolated Status LEDs Outputs – high current DC Active high I/O 	<ul style="list-style-type: none"> 4 voltage free inputs 	<ul style="list-style-type: none"> 4-20mA or 0-10V analogue output Electrically isolated Fast 400Hz update 2 digital I/O 	<ul style="list-style-type: none"> Nonvolatile alibi memory storage (6M bytes) Compatible with later versions of software

R400-765-251

R423 Panel Mount

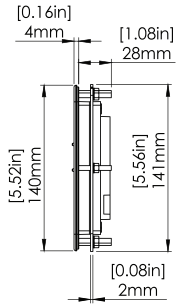
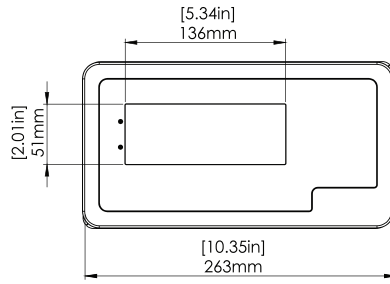
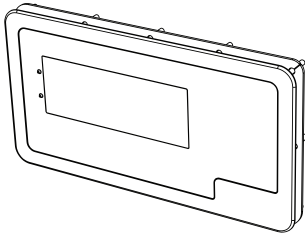

R427 Full Housing

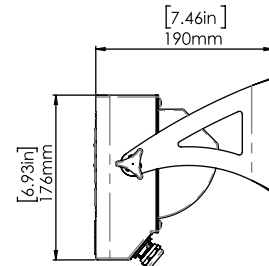
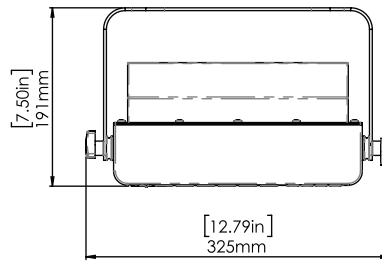
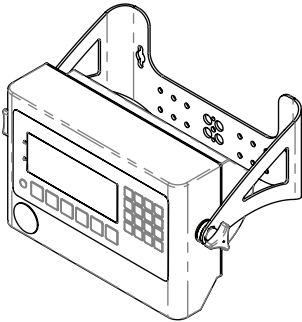
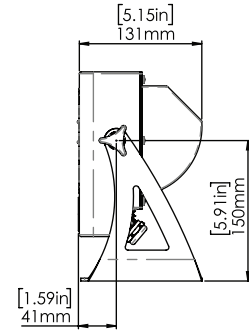
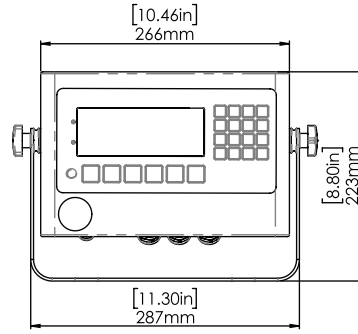
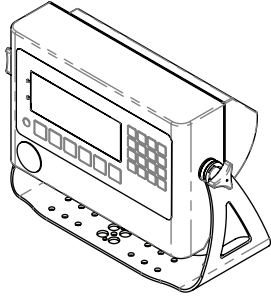

Local Dealer



Contact Us